



Quantum Machine Learning for HEP Detector Simulations

FSP CMS Workshop 2021

Florian Rehm [CERN openlab, RWTH Aachen]

Sofia Vallecorsa [CERN openlab], Kerstin Borrás [DESY, RWTH Aachen],
Dirk Krücker [DESY], Simon Schnake [DESY, RWTH Aachen]

Calorimeter Simulations

- Calorimeter simulations are based on Geant4
- Simulations use about 50% of the resources of the worldwide LHC grid
- LHC high luminosity phase requires 100 times more simulated data*

→ **Develop a new approach which occupies less resources**

→ **Employ deep learning**

→ **Already done: We reached a 150 000x speed-up using GANs**



*A Roadmap for HEP Software and Computing R&D for the 2020s
<https://doi.org/10.1007/s41781-018-0018-8>

Now: Quantum Computing

- **Explore potential of quantum computing**
 - Make use of quantum properties (entanglement, superposition)
 - Hope to solve problems faster and / or more accurately
 - “Quantum Advantage” not yet reached → only initial investigations
 - Understanding advantages and challenges
- Use case: calorimeter simulations
 - Using simplified models

Training Data

- 3D particle shower images
- Average the image over z-axis \rightarrow 1D image
- Down sample to only 8 pixel
- Average all of input energies \rightarrow Only one distribution

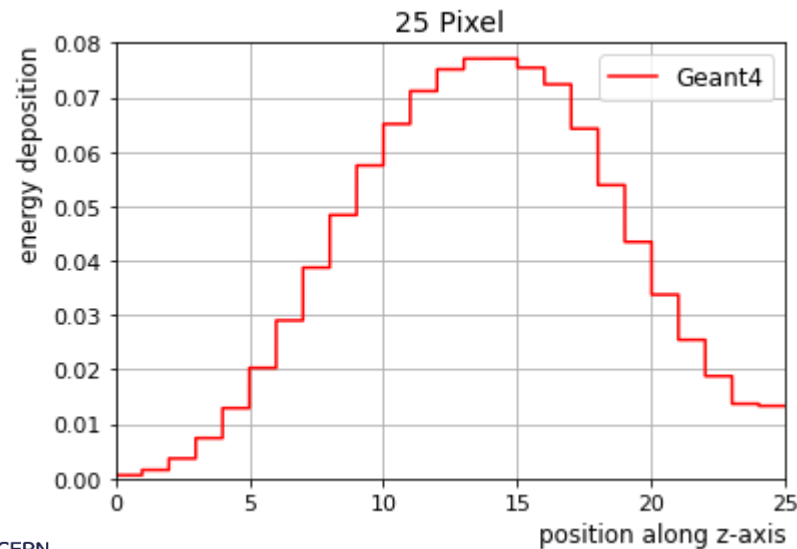
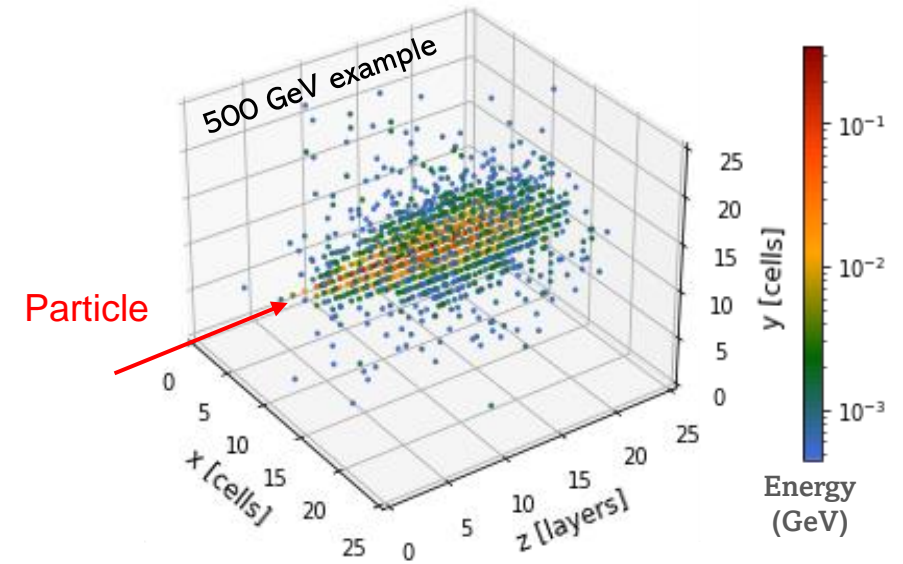

down sampling

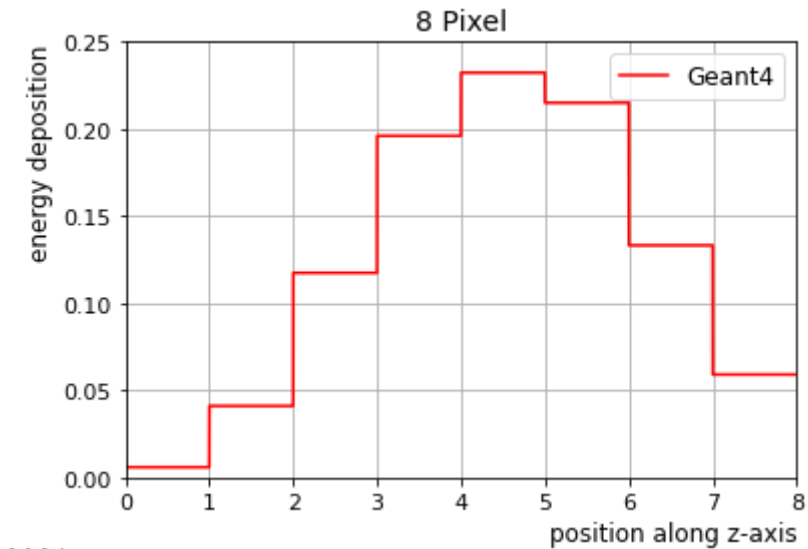

Hybrid qGAN

Quantum Generative Adversarial Networks

- Hybrid quantum – classical ansatz

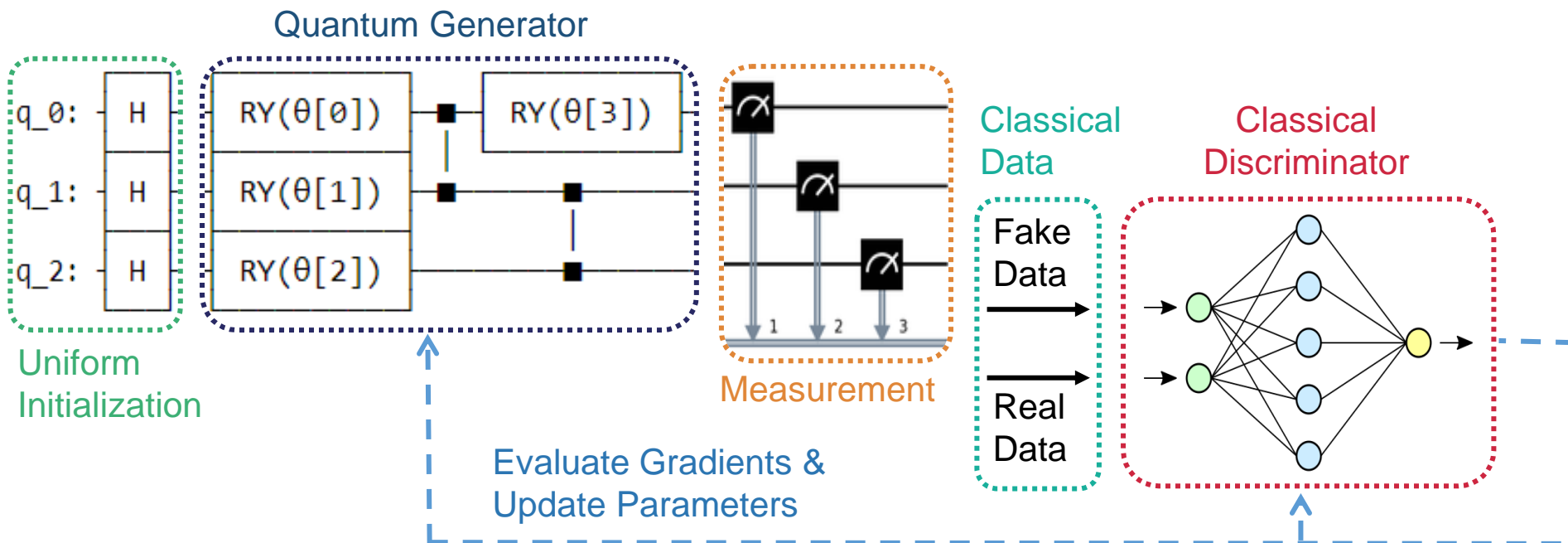



1D Quantum GAN

1D Quantum Generator Circuit

- Only 1D 8-pixel images
 - 3 qubits ($2^3 = 8$) in quantum generator circuit
 - 8 quantum states: $|000\rangle, |001\rangle, |010\rangle, |011\rangle, |100\rangle, |101\rangle, |110\rangle, |111\rangle$
- Modified a Qiskit qGAN model developed by IBM*

* https://qiskit.org/documentation/machine-learning/tutorials/04_qgans_for_loading_random_distributions.html

Quantum Generator Circuit:

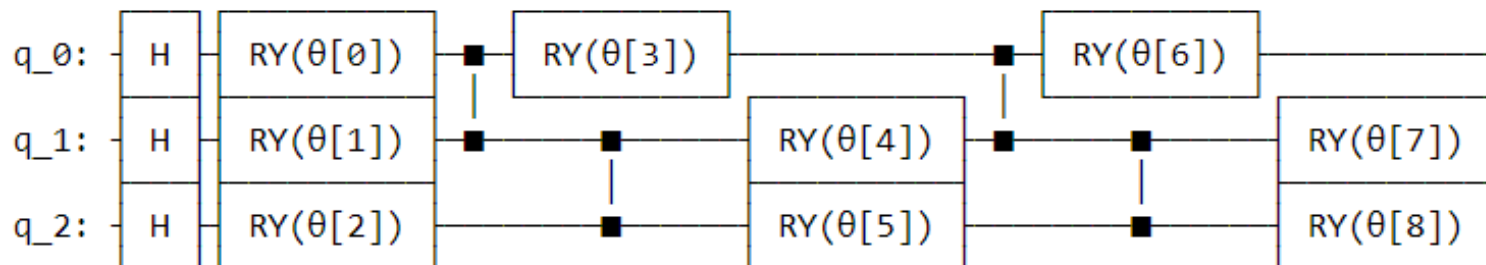

Gates:

$$\boxed{H} = \frac{1}{\sqrt{2}} \begin{bmatrix} 1 & 1 \\ 1 & -1 \end{bmatrix}$$

$$R_y(\theta) = \begin{pmatrix} \cos\left(\frac{\theta}{2}\right) & -\sin\left(\frac{\theta}{2}\right) \\ \sin\left(\frac{\theta}{2}\right) & \cos\left(\frac{\theta}{2}\right) \end{pmatrix}$$

$$\begin{array}{c} \text{---} \\ | \\ \text{---} \end{array} \text{ or } \begin{array}{c} \text{---} \\ \bullet \\ | \\ \boxed{Z} \\ | \\ \text{---} \end{array} = CZ = \begin{pmatrix} 1 & 0 & 0 & 0 \\ 0 & 1 & 0 & 0 \\ 0 & 0 & 1 & 0 \\ 0 & 0 & 0 & -1 \end{pmatrix}$$

1D Quantum Simulator

Without Noise

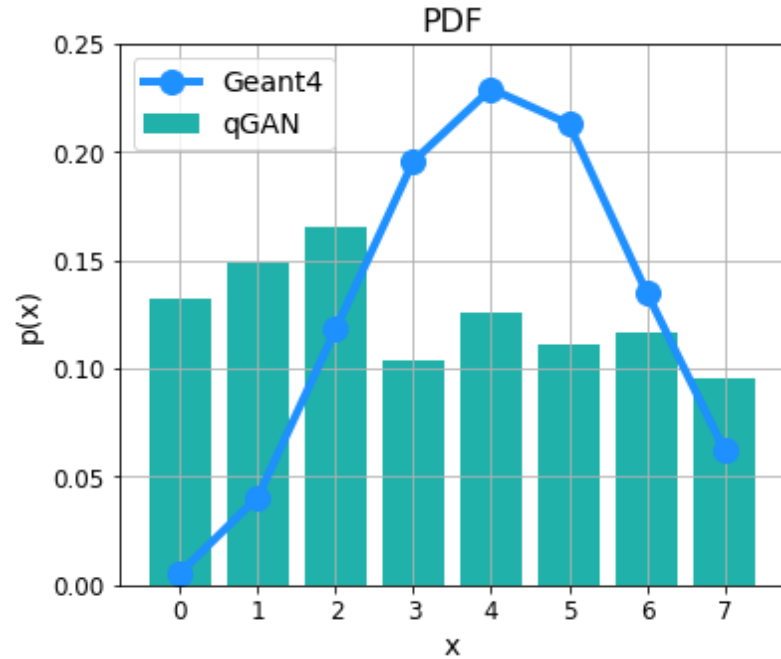

Uniform Initialization

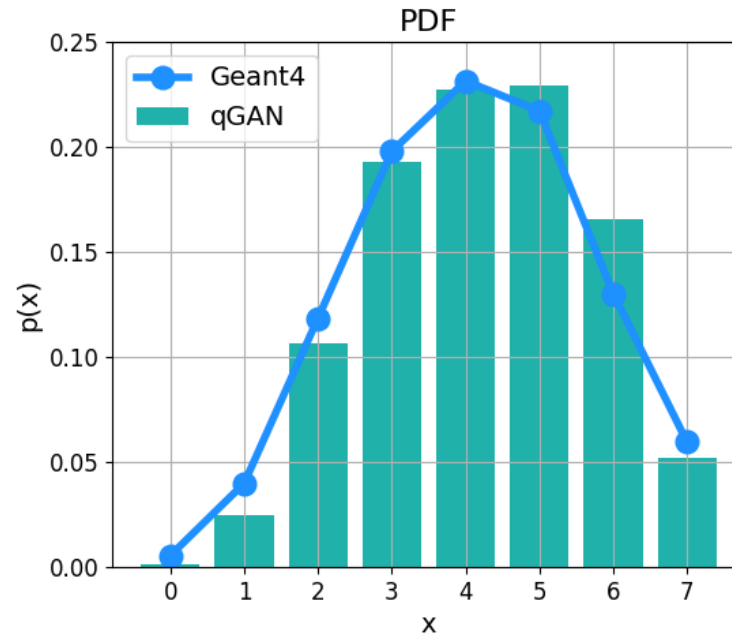

Trained Model

→ Good results

1D qGAN

Optimize Training

- Training time ~ 1 day for 3000 epochs
 - → speeding training up
- Hyperparameter optimizations:
 - Higher learning rate
 - Implement exponential learning rate decay
 - Different generator and discriminator learning rate
 - Train discriminator more often than generator
- Results:
 - **10x speed up** in training time
→ Only ~300 epochs instead of > 3000

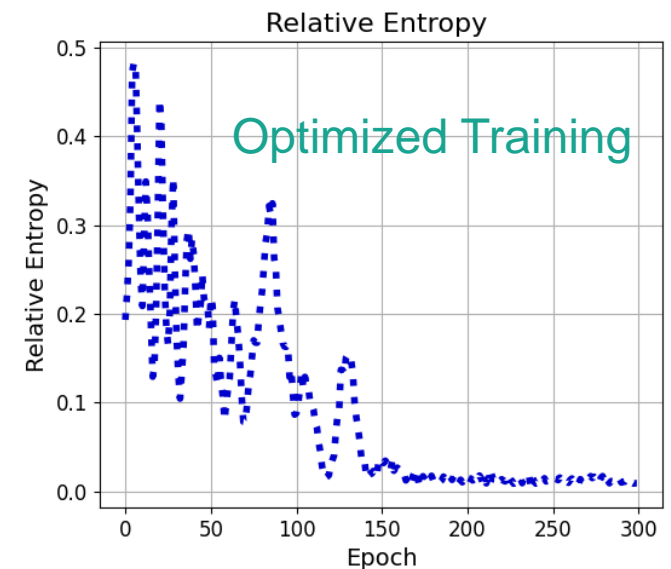
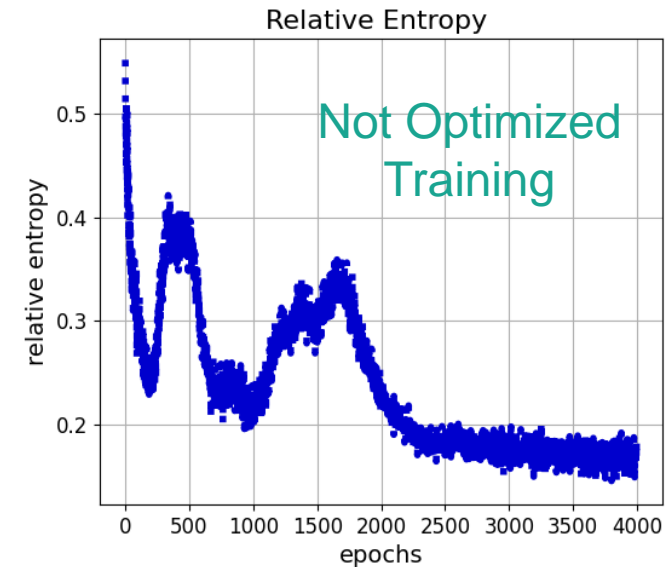

1D qGAN Robustness

- Run 23 trials with same hyperparameters

→ Stable training
→ On average good accuracy

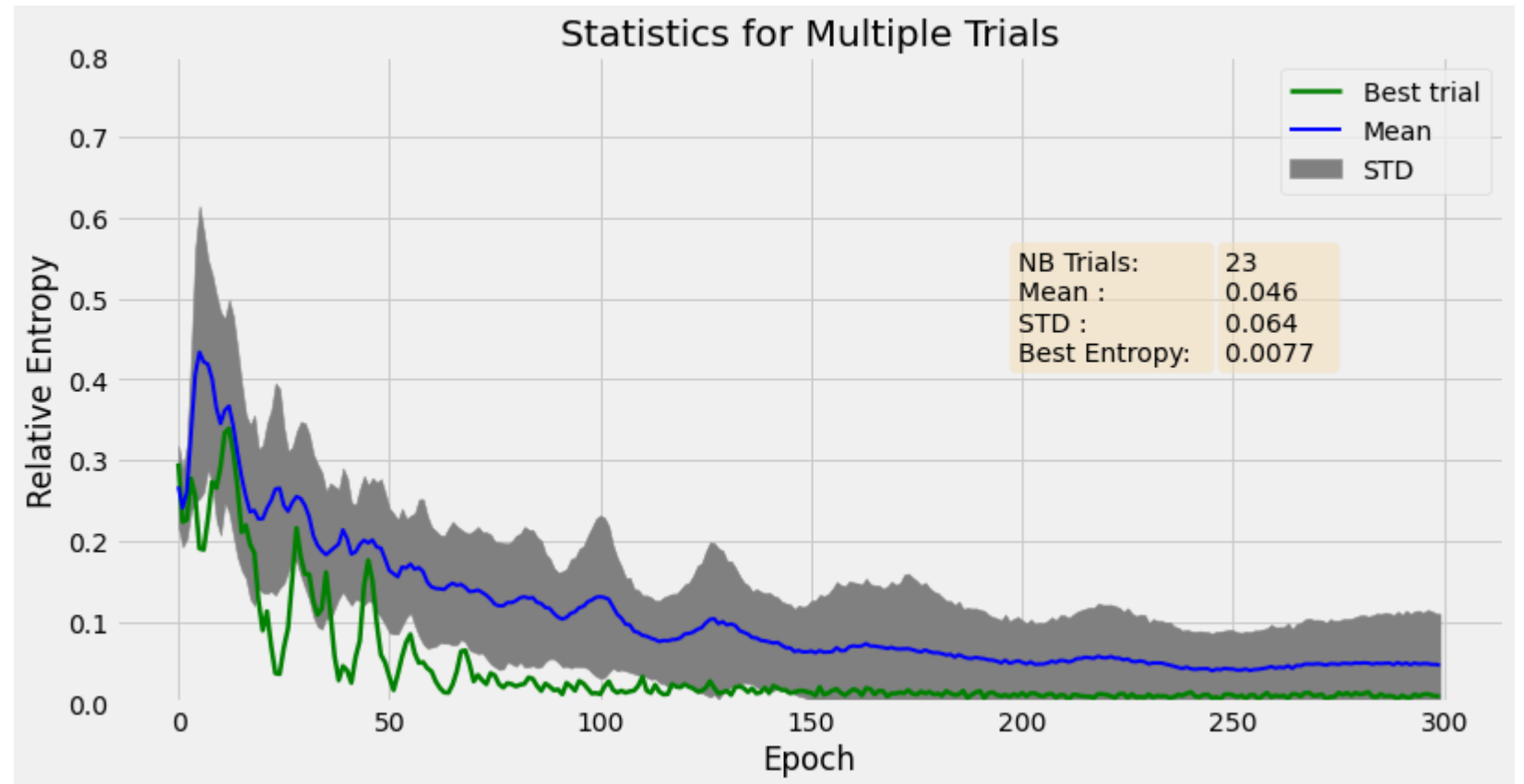

1D qGAN with Noise

Readout Noise Only

- We applied readout noise to the qubit measurements
 - Noise model from IBMq belem quantum computer

Qubit Number	0	1	2
Readout Error	3.6%	4.7%	9.6%

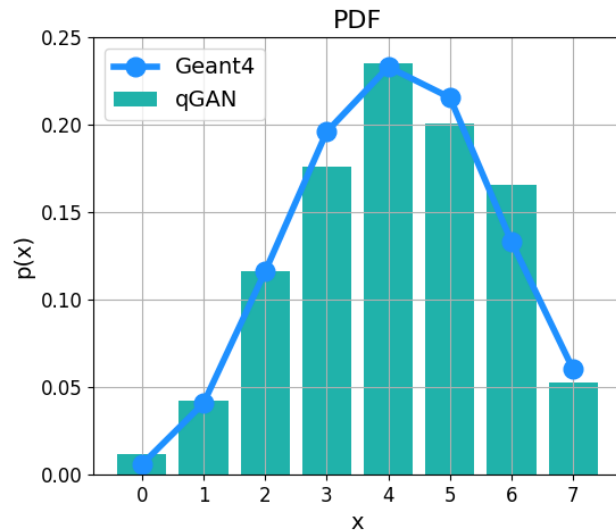

→ No decrease in accuracy

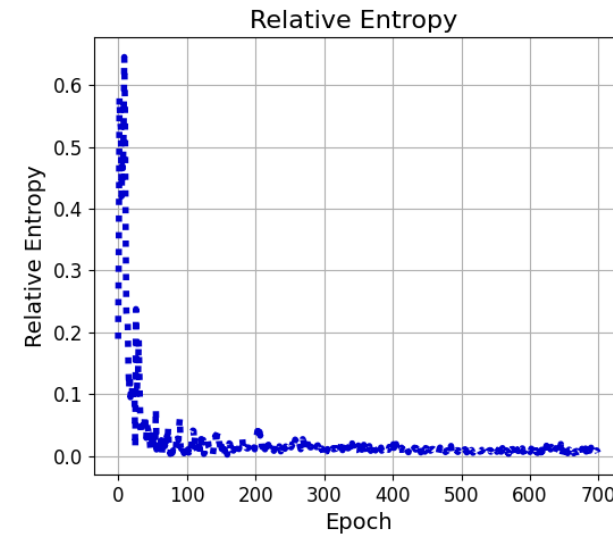

→ Fast convergence

1D qGAN with Noise

Full Noise Model

- We applied noise to the qubit gates (readout noise + gate level noise)
 - Noise model from IBMq belem quantum computer
 - Average gate level noise: 4.32%

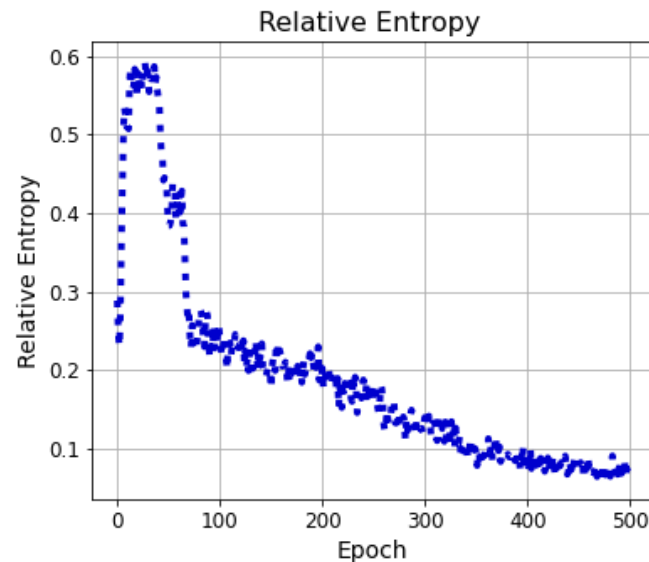

→ Good entropy

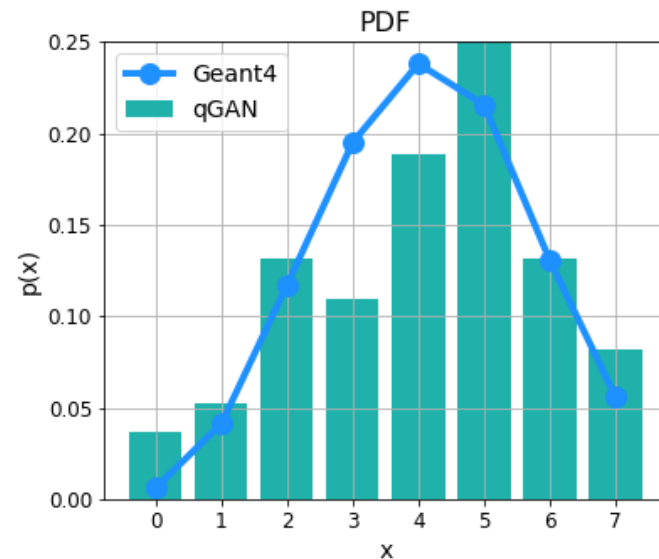

→ Lower accuracy

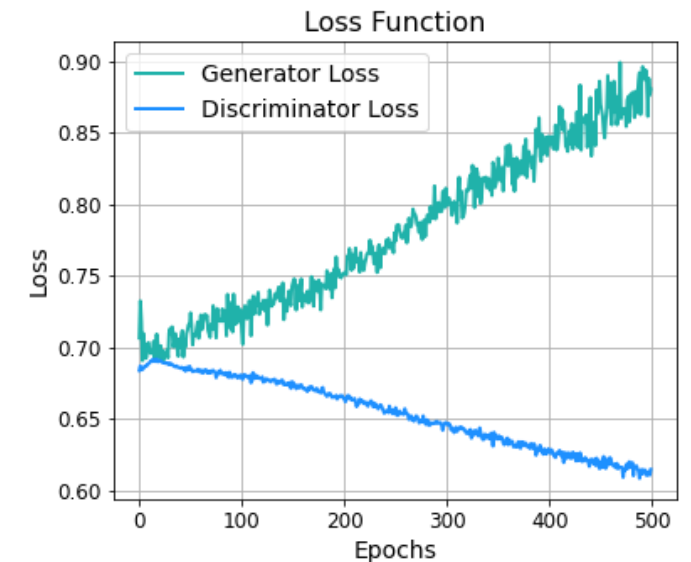

→ Non-converging losses



2D Quantum GAN

2D qGAN

2D Data Representation

2D: $8 \times 8 = 64 \text{ pixels} = 2^6 \rightarrow 6 \text{ qubits}$

1. Down sample
2. 1D stacking
3. Apply logarithm

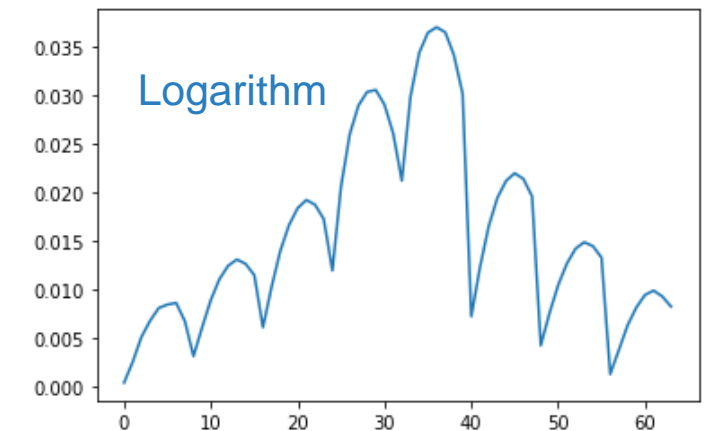
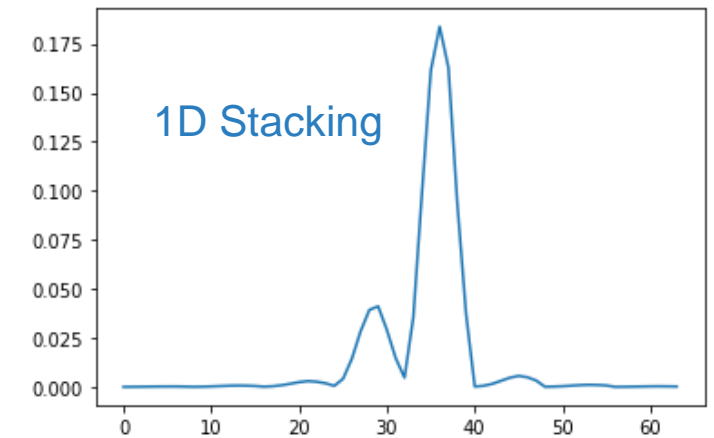
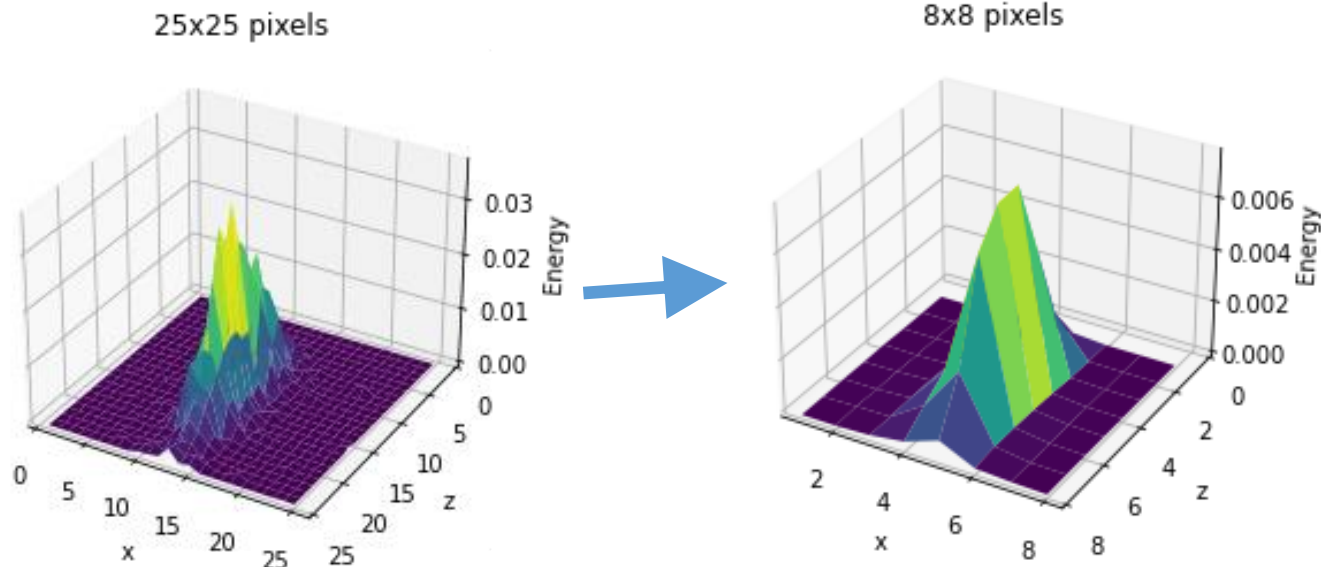

2D Quantum Generator Circuit

Tree Tensor Network Architecture

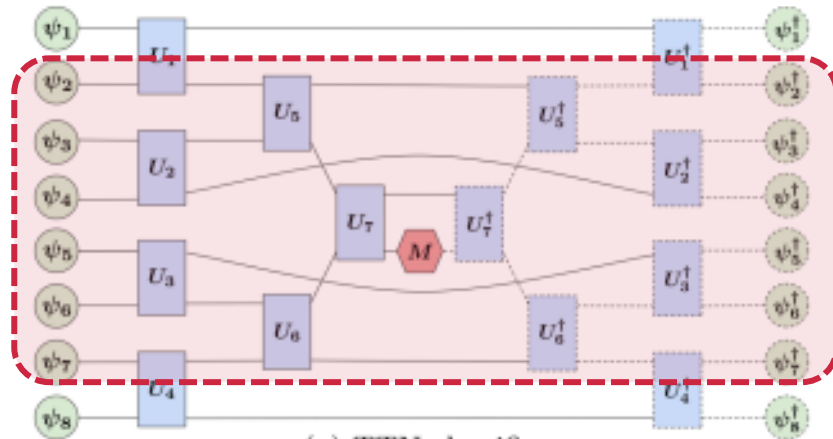
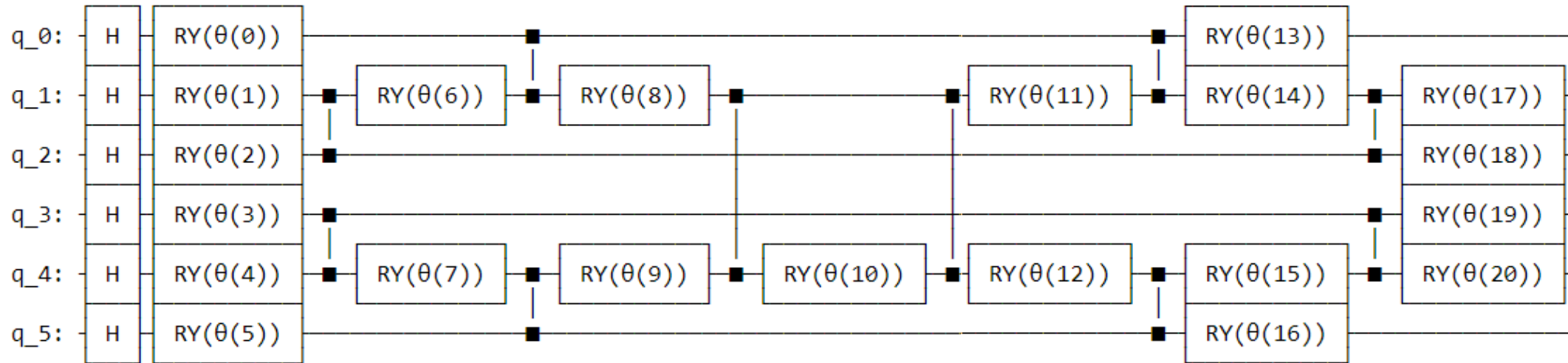

(a) TTN classifier

Only 6 qubits

Grant, E., Benedetti, M., Cao, S. *et al.* Hierarchical quantum classifiers. *npj Quantum Inf* 4, 65 (2018). <https://doi.org/10.1038/s41534-018-0116-9>

2D qGAN

Best Results

- Run on quantum simulator without noise

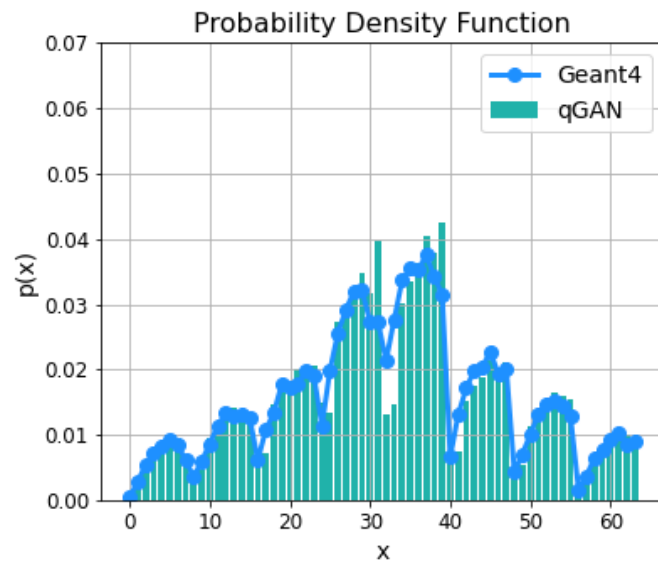

Trained Model

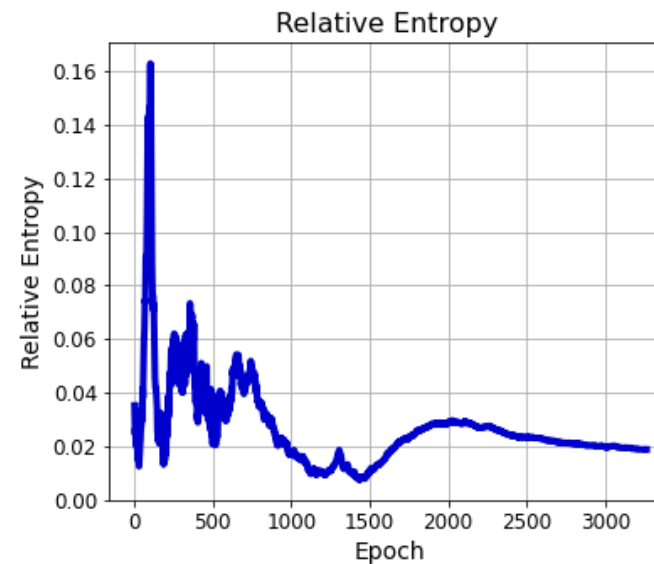

qGAN Future Work

- 2D qGAN:
 - Improve training convergence
 - Rare that training converges
 - Decrease training time: recently ~5 days
 - Hyperparameter optimization
- 1D qGAN:
 - More tests with the full noise model
 - Test error mitigation techniques
 - Conditional qGAN



QUESTIONS?

Quantum Machine Learning for HEP Detectors Simulations

Florian Rehm [CERN openlab, RWTH Aachen]

Sofia Vallecorsa [CERN openlab], Kerstin Borrás [DESY, RWTH Aachen], Dirk Krücker [DESY], Simon Schnake [DESY, RWTH Aachen]